

EINBAUANLEITUNG

ELEKTROKIT ANHÄNGERKUPPLUNG

INSTALLATION INSTRUCTION

ELECTRICAL KIT FOR TRAILER COUPLING

ISTRUZIONI DI MONTAGGIO

SEZIONE ELETROTECNICAL ACCOPPIAMENTO RIMORCHIO

NOTICE DE MONTAGE

KIT ELECTRIQUE DU DISPOSITIV DE REMARQUE

ARTIKEL-NR: 21400006J

D UNIVERSAL 13 POL
MIT AFC MODUL

GB UNIVERSAL 13 PIN
WITH AFC MODUL

I UNIVERSALI 13 POLI
CON MODUL AFC

F UNIVERSEL 13 BORNES
AVEC MODULE AFC

AFC = AUTOMATIC FLASH CONTROL

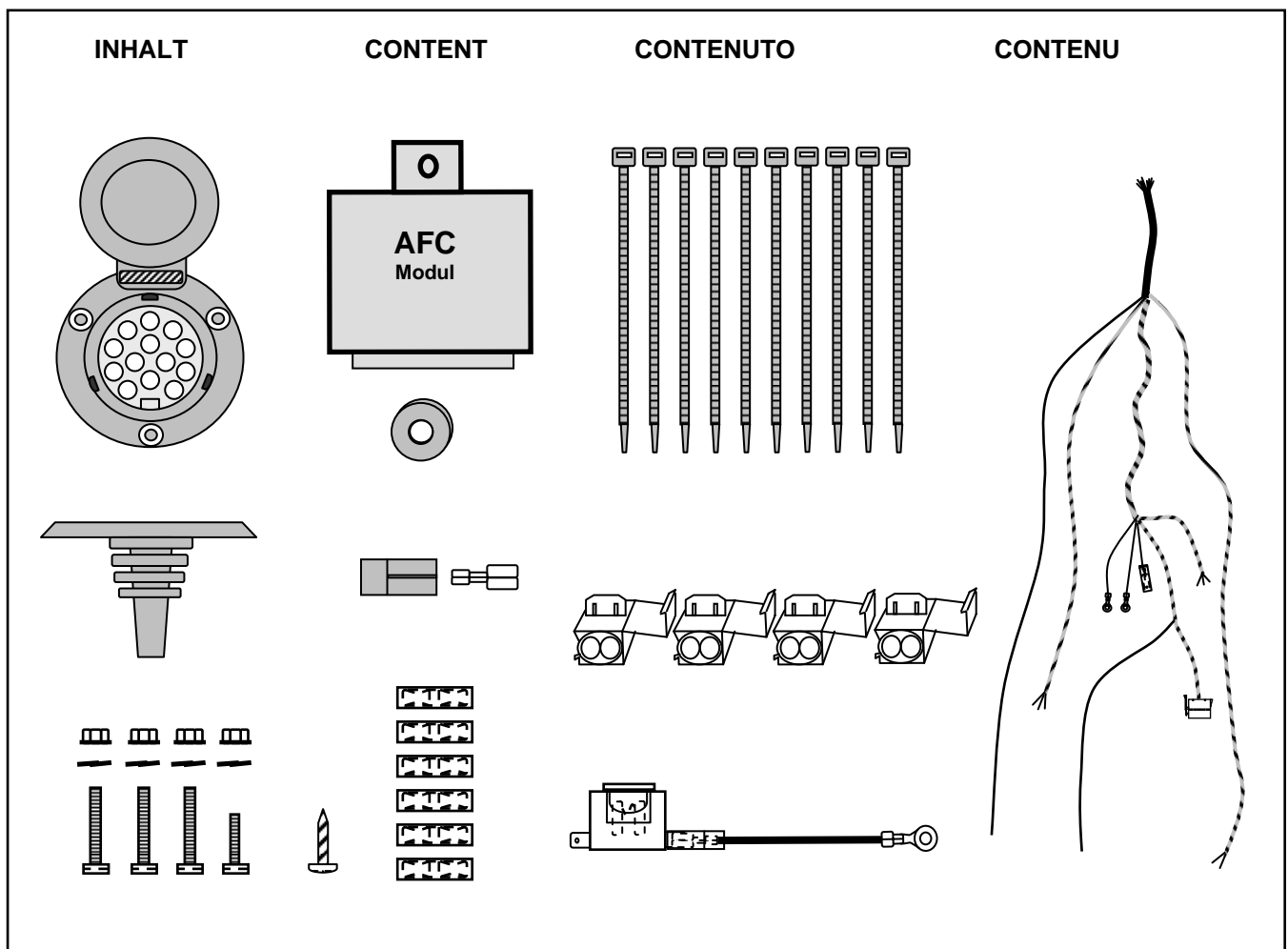

	D	GB	I	F
bl	blau	blue	blu	bleu
br	braun	brown	brun	bruno
ge	gelb	yellow	giallo	jaune
gn	grün	green	verde	vert
gr	grau	gray	grigio	gris
rt	rot	red	rosso	rouge
sw	schwarz	black	nero	noir
ws	weiss	white	bianco	blanc
L	links	left	a sinistra	à gauche
R	rechts	right	a destra	à droite

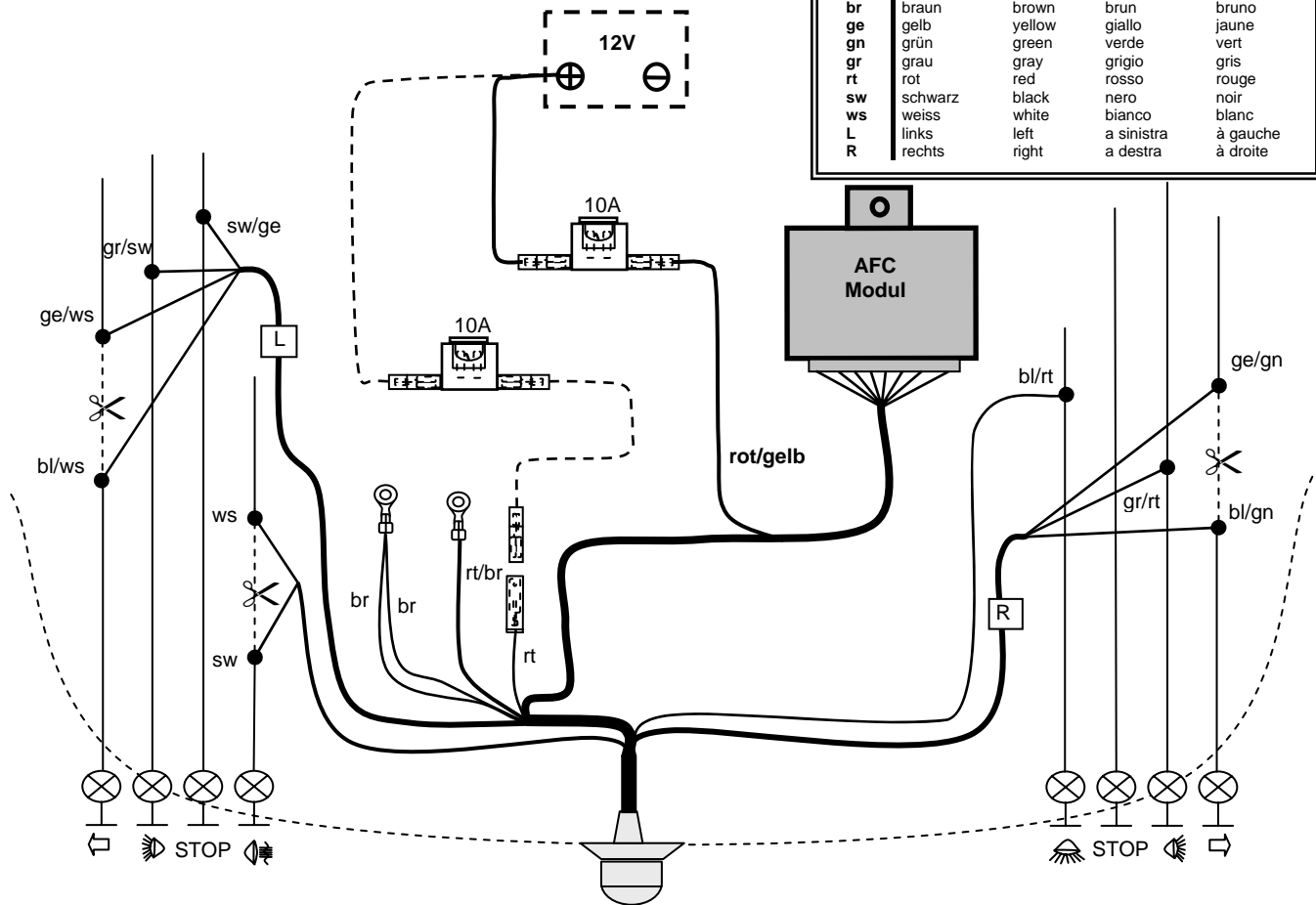

1.

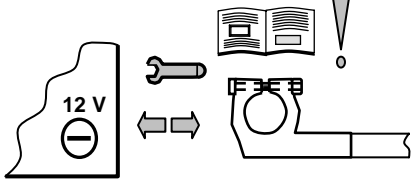

2.

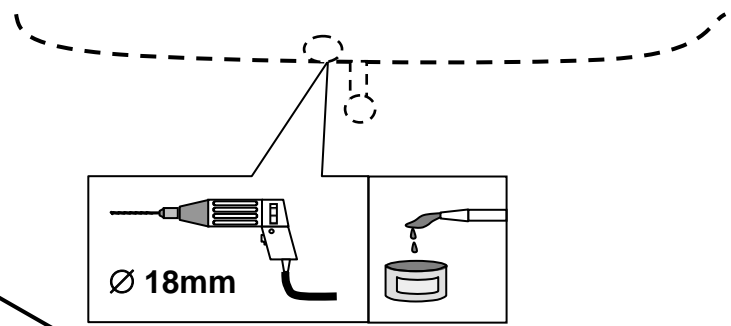

3.

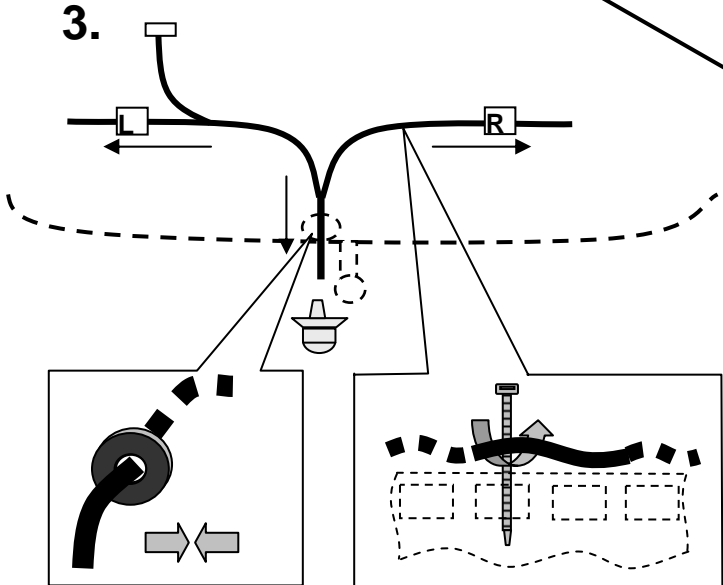

4.

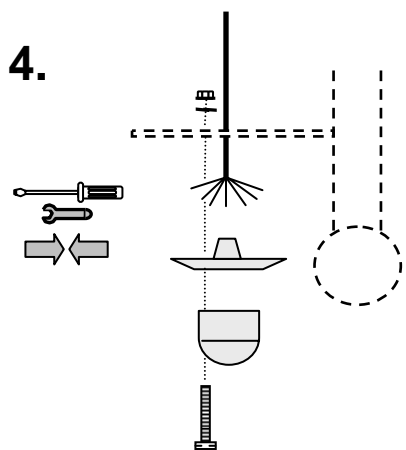

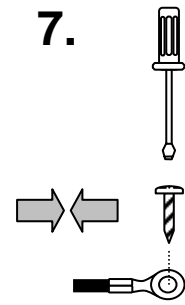
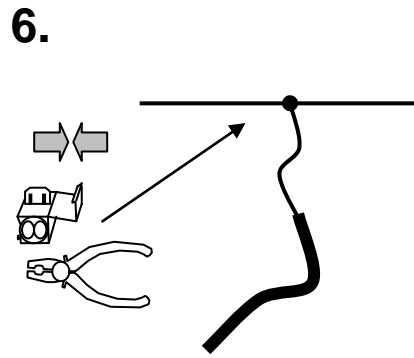
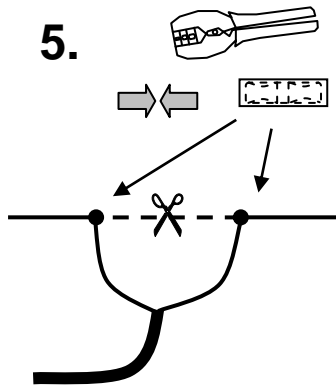

8.

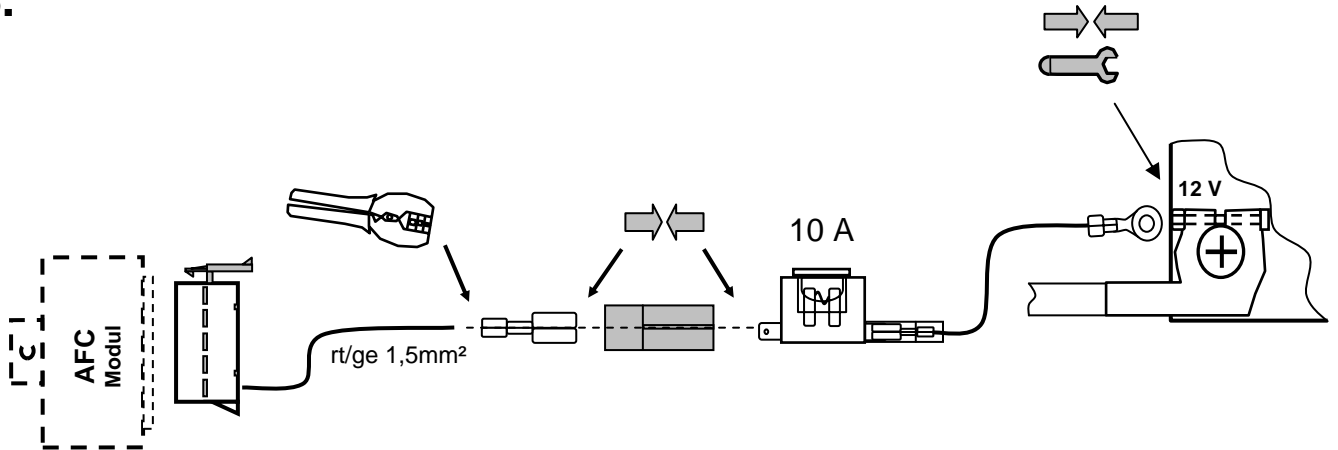

9.

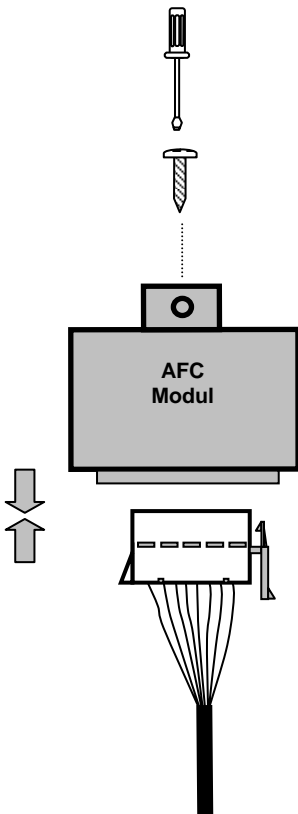

10.

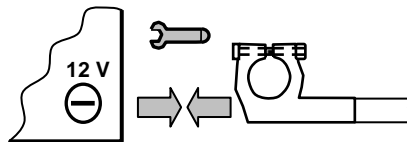

Funktionskontrolle. Mit einem geeignetem Prüfgerät oder einem Anhänger durchführen. Die Funktionskontrolle mit einem Prüfgerät ohne Lastwiderstände (Diodenprüfgerät) ist nicht möglich.

Check functions. Execute with a suitable testing set or trailer. The functions check with a testing set without electric resistance is not possible.

Prova di funzionamento. Controllo con un Istrumento adatto o con il rimorchio. La prova di funzionamento senza resistenza del carico non è possibile.

Contrôle de fonction. Exécutez avec un instrument de vérification approprié ou une remorque. Le contrôle de fonction avec un instrument de vérification sans résistance électrique n'est pas possible.

Kontaktbelegung 7 und 13 polige Steckdose

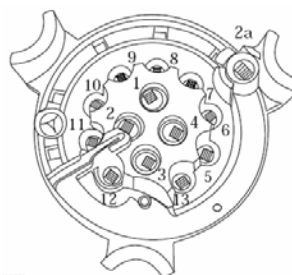

7P Kontakt contact contatto contact	13P Kontakt contact contatto contact	Stromkreis circuit circolazione elettrica circuit	Aderfarbe core colour colore cavo couleur de brin	
1/L	1	Fahrtrichtungsanzeiger links direction indicator left indicatore di direzione sinistro Indicateur de direction gauche	schwarz / weiss black / white nero / bianco noir / blanc	1,0 mm ²
2/54g	2	Nebelschlussleuchte Anhänger fog rear light retronebbia feu arrière de brouillard	weiss white bianco blanc	1,0 mm ²
3/31	3	Masse (für Kontakt-Nr. 1 – 8) earth (contact No. 1-8) massa isolata (per contatti 1-8) terre (contact 1-8)	braun brown bruno brun	1,5 mm ²
4/R	4	Fahrtrichtungsanzeiger rechts direction indicator right indicatore di direzione destro Indicateur de direction droite	schwarz / grün black / green nero / verde noir / vert	1,0 mm ²
5/58R	5	Schlussleuchte rechts right tail light luce posizione posteriore destra feu arrière droite	grau / rot gray / red grigio / rosso gris / rouge	1,0 mm ²
6/54	6	Bremsleuchte stop lights luci stop feux de stop	schwarz / rot black / red nero / rosso noir / rouge	1,0 mm ²
7/58L	7	Schlussleuchte links left tail light luce posizione posteriore sinistra feu arrière gauche	grau / schwarz gray / black grigio / nero gris / noir	1,0 mm ²
	8	Rückfahrleuchte reversing light luce retromarcia feu de recul	blau / rot blue / red blu / rosso bleu / rouge	1,0 mm ²
	9	Stromversorgung / Dauerplus power supply (battery plus) positivo da batteria alimentation (batterie plus)	rot red rosso rouge	2,5 mm ²
	10	Ladeleitung Plus charging circuit plus alimentazione sotto chiave circuit d'alimentation plus		
	11	Masse für Kontakt-Nr. 10 earth contact No. 10 massa per il contatto 10 (erre contact 10)		
	12	Steuerleitung Anhängererkennung trailer identification control line attacco ricono scimento rimorchio circuit d'identification de remarque	nicht belegt	--
	13	Masse für Kontakt-Nr. 9 earth (contact No. 9) massa (per il contatto 9) terre (contact 9)	rot / braun red / brown rosso / bruno rouge / brun	2,5 mm ²
8	2a	Nebelschlussleuchte Zugfahrzeug fog rear light on vehicle retronebbia automobile feu arrière de brouillard á voiture	schwarz black nero noir	1,0 mm ²